

WIN  CARE

Luna IPx4

Ceiling hoist

User manual

Important information

Please read this user manual carefully before using the product!

This user manual is intended as a guide for caregivers and other users, as well as technical personnel during servicing and maintenance of the product.



Scan the QR code for more information

Date: 04-10-2021

Version:11

CONTENTS

1	PURPOSE, SAFETY AND USE	4
1.1	Purpose	4
1.2	Essential Performance	4
1.3	Safety instructions	4
1.4	Before use	5
1.5	Terminology	6
1.6	Unpacking	7
1.7	Transport	7
2	INSTALLATION AND OPERATION	7
2.1	Mounting and detaching Luna	7
2.2	Mounting and detaching of the spreader bar	10
2.3	Pictograms and functions	11
2.4	Operating	12
2.5	Operating safety functions	12
2.6	Charging	14
3	USING LUNA	15
3.1	Using lifting slings	15
3.2	Room to room transfer	16
3.3	Using Luna in a shower or bathing environment	18
4	MAINTENANCE	18
4.1	Cleaning	18
4.2	Storage	18
5	CHECK, WARRANTY AND TROUBLESHOOTING	19
5.1	Annual inspection	19
5.2	Troubleshooting	19
6	TECHNICAL DATA AND DIMENSIONS	20
6.1	Technical specifications	20
6.2	Dimensions	21
7	ENVIRONMENT AND QUALITY	22
7.1	Expected lifetime	22
7.2	Disposal	22
7.3	Battery	22
7.4	Quality	22
7.5	Symbols and abbreviations	22
8	ACCESSORIES	23
9	EMC data	24

1 PURPOSE, SAFETY AND USE

1.1 Purpose

The Luna IPx4 Ceiling hoist/lift, referred to in this manual as Luna, is available in different models. If not specified, this manual is valid for all models. The Luna also comes in a 2-channel model, used for accessories such as Luna Mover. Use of the extra channel is described in the accessory's user guide.

The Luna is designed for making easy user/patient transfers from e.g., bed to wheelchair, to toilet etc. in institutions such as nursing homes, hospitals, care centres and in homecare.

The Luna can be used as a ceiling mounted hoist/lift or as a mobile hoist/lift in fixed or movable track systems.

The product is not bound to one person only but can easily be passed on to a new user after thorough cleaning (see section 4.1).

1.2 Essential Performance

Intended use: Lifting and lowering of patient.

If the Luna, shows sensitivity to continued phenomena with electrical interferences, the user can be lowered by means of the emergency lowering button (see section 2.5).

1.3 Safety instructions



Important – Warning!

This user guide must be read thoroughly before product is taken into service.

- All parts must be mounted correctly and according to this user manual.
- There must be no indication of wear and tear on the Luna, track system or lifting sling.
- NEVER begin lifting if there is suspicion of any defect (abnormal sound, loose brackets etc.) In such cases the Luna must be taken out of service immediately and you must contact the dealer or WinnCare.
- Depending on the model the lifting capacity is 200 kg or 275 kg (440 lbs or 606 lbs), and this must never be exceeded. When using Luna along with other items such as slings, spreader bars or transportable track systems it is always the item with the LOWEST weight capacity that decides the maximum lifting capacity.
- Make sure that the Luna or the spreader bar cannot come into contact/hit the user/patient while mounting the sling on the spreader bar.
- A caregiver must always be present when the Luna is used.
- Make sure that neither caregiver nor patient can be injured when carrying out lifts and transfers. Always check surroundings and move obstacles out of the way.
- Never lift higher than necessary.
- According to EMC. Electrical interference from portable RF communications equipment including antennas, can affect medical electrical equipment and should not be used within a distance of minimum 30 cm (12 Ines) from Luna IPx4.

1.4 Before use

The caregiver or user is responsible for making the following checks before use:

- Personnel must have received qualified instructions in how to use the Luna.
- The Luna is being used in track systems produced or approved by Winncare.
- Installation of track system for the Luna is carried out by qualified installers approved by dealer or Winncare.
- Luna can only be fitted with spreader bars supplied by Winncare.
- Luna has been developed for use with ErgoSlings and other sling products approved by Winncare. See brochure for ErgoSlings.
- The Luna is intended for use under normal temperatures (+2°C/35.6°F to +40°C/104°F) and relative humidity (40 – 90%).
- If the Luna is used near shower system or bath, make sure that the Luna or hand control is not submerged (see section 3.3).
- For use in aggressive chemical environments (see section 5.1).

Safety checks:

- Check lifting strap for wear and tear or damage. If there is any sign of a defects, the Luna must be taken out of use immediately.
- Make sure the emergency stop has not been activated. If the red lamp is lit up, press, and hold the reset button for 5 seconds to release the emergency stop.
- Check the up/down function, if any abnormal sound is heard the Luna must not be used before a service check has been performed by a qualified technician.
- Make sure that the strap can move freely into the Luna without twisting.
- Check lifting sling for any damage especially with regards to lifting straps. The sling must not be used if damage or defects are detected.
- If in doubt on how to use the Luna, please contact the dealer or Winncare for advice and guidance.

1.5 Terminology

Luna mounted in strap:

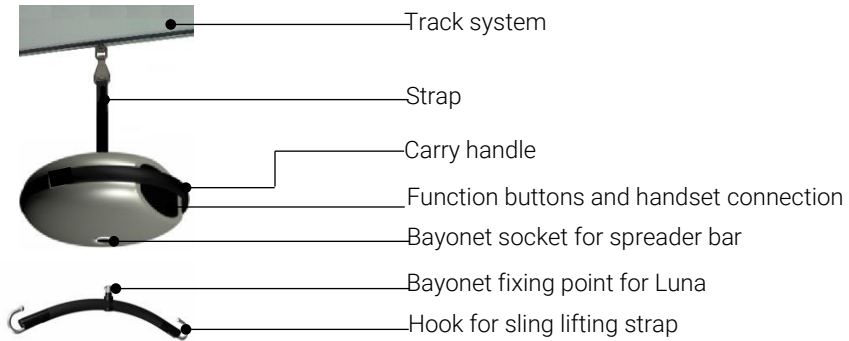

Luna mounted on the track:

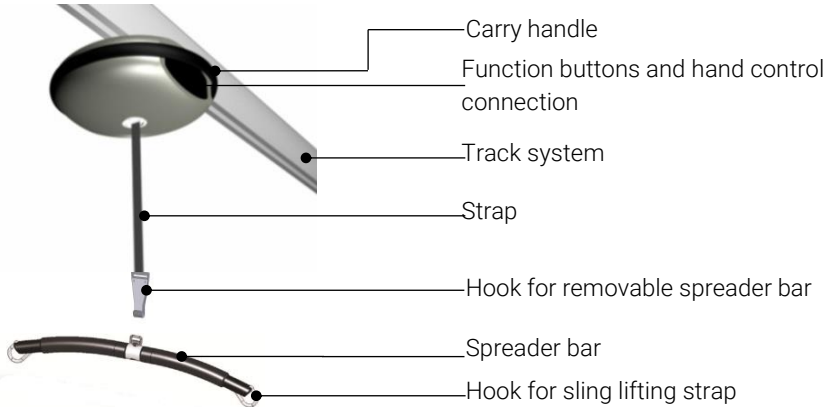

Luna SKY mounted directly in track:

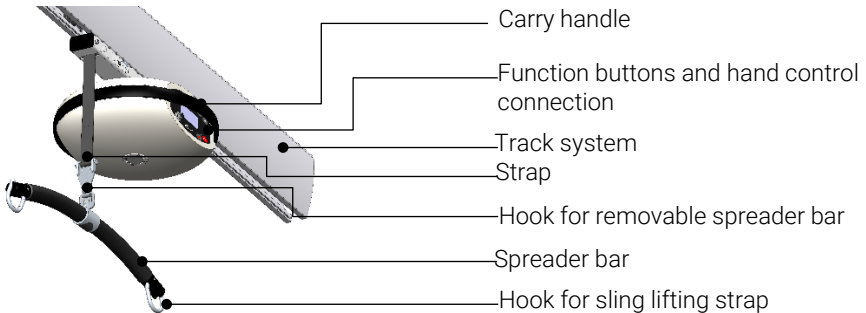

1.6 Unpacking

Check that all the parts are present and undamaged. Any suspicion of damage or shortage should be reported immediately to the dealer or Winncare.

We recommend keeping and store original packaging for later transport to other sites or for return shipment to Winncare in case of repair or annual check.

Contents of the box:

- Luna cassette
- User manual
- Hand control (accessories)
- Spreader bar (accessories)
- Charger (accessories)
- Carts (only for Luna SKY)



1.7 Transport

The Luna is most safely transported using the original packaging. Symbols are printed on the packaging to ensure the best information for transport companies.

2 INSTALLATION AND OPERATION

2.1 Mounting and detaching Luna

The Luna can be mounted in two different ways to meet specific needs. By choice from the buyer the Luna is prepared, delivered and ready to be mounted in one of the following methods.



Be aware that the Luna weighs 6.7 kg (14.8 lbs). Luna SKY 7.4 kg (16.3 lbs).

A) Luna mounted directly on the cart

The Luna is mounted directly on a cart in the track system. (Fig. 2.1A).

- 1) Lift up the Luna and connect the bayonet on the cart into the Luna socket (when connecting you will feel easy resistance from spring).
- 2) Now turn the Luna clockwise 90° and await a little click - this indicates correct mounting.

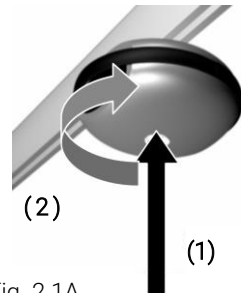

Fig. 2.1A



If the Luna is not correctly mounted an electronic safety device prevents to operate

Detaching the Luna from the cart

- 1) Push the Luna upwards toward the cart (feel easy resistance from the spring).
- 2) Turn the Luna 90° counterclockwise for detachment.

B) Luna mounted by the strap

Use the hook on the strap for mounting directly onto the cart (Fig. 2.1B)

- 1) Lift up the Luna and attach the hook to the cart by connecting the strap hook directly to the cart in the track.
- 2) Await click for correct attachment. Safety spring-plate on the hook must be locked to prevent the Luna from detachment.

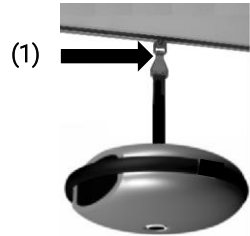

Fig. 2.1B



Always check that the hook is locked before using the Luna.

Detaching the Luna strap from cart

- 1) The hook can be released by using an extension arm
- 2) The extension arm is placed at the lower part of the hook.
- 3) Push up the extension arm to release the spring-plate on the hook and unhook the Luna strap from the cart.
- 4) Lower the Luna into the cradle on the trolley and leave the strap slightly slackened.

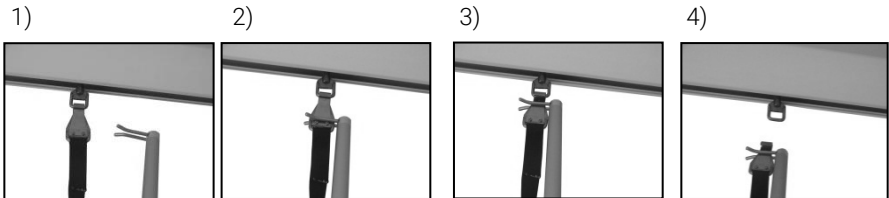

Extension arm or Luna Trolley with extension arm can be purchased from Winnicare or dealer.

See order number in section 8, Accessories

C) Luna SKY mounted in the track

The Luna SKY ceiling hoist is mounted directly into the track with two carts. Each cart has its own mounting block which is to be placed in the Luna SKY square tube and must be tightened securely (Fig. 2.1C).

- 1) Mount carts in the Luna SKY square tube.
- 2) Raise the Luna SKY to the track system and push both carts into an opening end of the track system.
- 3) Mounts the four screws with Nord-lock washers and tighten screws to 8 Nm.
- 4) When dismount Luna SKY from the track system, the procedure must be in reverse order.

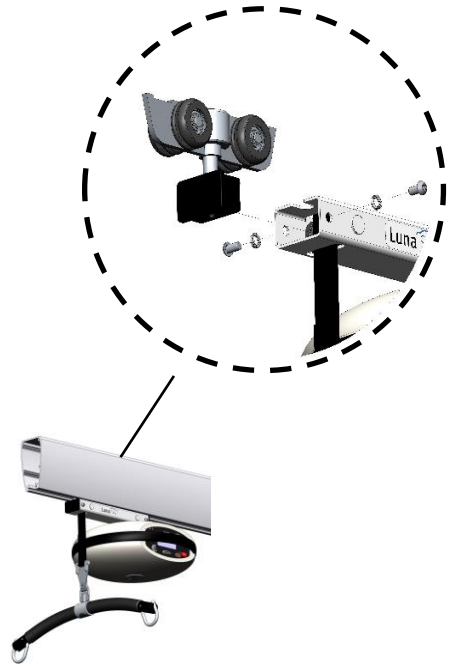

Nord-lock washers must always be used when installing carts for Luna SKY.

D) Room for room assembly with two Luna SKY ceiling hoists

Note: When using Luna SKY for room-to-room transfer, the strap outlet of both Luna SKYs should face each other as shown below:

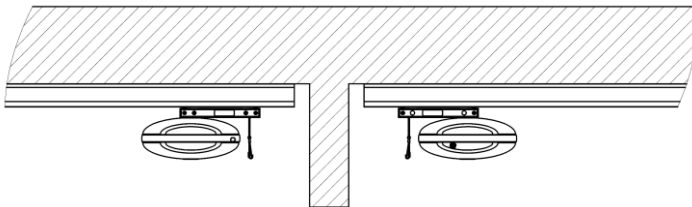

Note: Transferring can also be performed with one Luna ceiling hoist and one Luna SKY ceiling hoist.

2.2 Mounting and detaching of the spreader bar

Depending on how the Luna is mounted, the spreader bar can be attached as follows.

A) Luna mounted directly on the cart

Mounting the spreader bar (Fig. 2.2A)

- 1) Lift the spreader bar. Hold the strap and press the safety spring-plate on the hook.
- 2) Attach the hook onto the attachment point on the spreader bar and release the safety spring-plate.
- 3) Ensure that the hook is safely locked onto the spreader bar attachment point.



Fig. 2.2A

Detaching the spreader bar

1)



2)

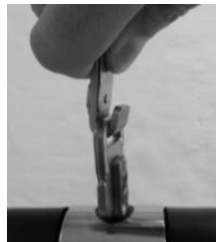

3)



- 1) Press in the spring-plate on the hook.
- 2) Tilt the hook to detach the spreader bar.

B) Luna mounted in strap

Mounting the spreader bar directly into the Luna

- 1) Fit the spreader bar bayonet into the socket on the Luna (when connecting you will feel a light resistance from spring).
- 2) Now turn the Luna clockwise 90° and await a little click - this indicates correct mounting (see fig. 2.2B).

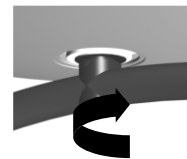

Fig. 2.2B



If the spreader bar is not correctly mounted an electronic safety device prevents operation of the Luna.

Detaching the spreader bar

- 1) Push the spreader bar upwards into the Luna (feel light resistance from the spring).
- 2) Turn the Luna 90° counterclockwise for detaching.

2.3 Pictograms and functions

(1) **ON** – If LED light is off, the Luna is in “sleep” mode. The LED light will turn on when the up (4) or down (3) button on the hand control is pressed.

(2) **BATT.** – Indicates battery level (see 2.6).

(3) + (4) **Up/Down** – Press and hold the Luna will move in the desired direction. Release the button to stop the movement.

Note: Works only with hand control (5) plugged in and LED light (1) must be on.

(5) **Plug** – Insert the hand control plug.

(6) **Data display** – Information about the Luna model, serial number and symbols information.

(7) **Emergency Lowering** – ONLY used in situations where it is necessary to lower a patient safely in case of a lift failure. This button must be held constantly to lower the unit. (See section 2.5)

(8) **STOP** – Press the emergency stop button to stop the Luna immediately. This function can be reset by pressing the reset button on the hand control for 5 seconds.

9) Reset – Used to reset the Luna after the use of the emergency stop - or lock function. Reset by holding the reset button for 5 seconds, the Luna will then be reactivated.

Reset can also be used to lock all functions to avoid unintended use by e.g., the patient. When the reset button is held, the LED light will show red, and all functions will be locked.

(10) **Option** – This option is not available on a standard hand control. The extra output can be e.g., the Luna Mover or an electrical spreader bar.

Side foil:

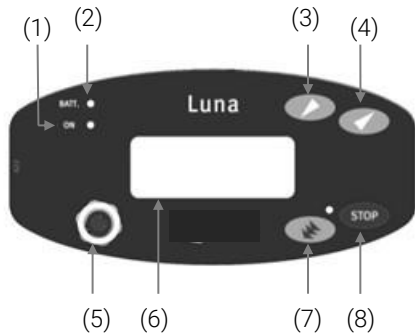

Hand control:

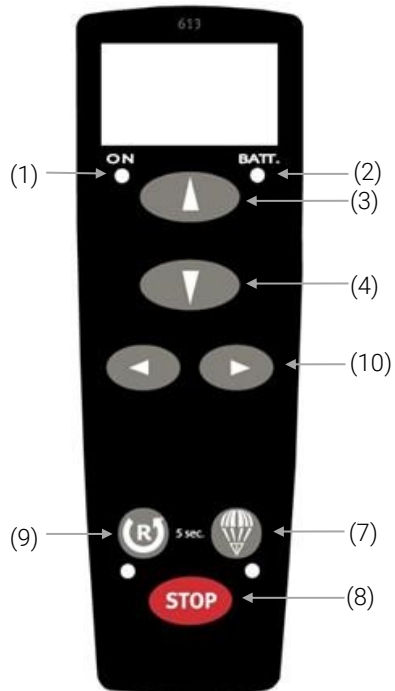

2.4 Operating

The Luna is ready for use, when the Luna cassette and the spreader bar are correctly mounted. When the hand control is connected to the plug inlet on the front panel, the Luna may start up in emergency stop mode. To release the emergency-stop, press and hold the reset button for 5 seconds. Test the up and down functions before using the Luna.

The Luna will move faster when not loaded in order to reach the user quickly. When the user is lifted, the speed will automatically reduce to increase the comfort and safety for the user.

2.5 Operating safety functions

Emergency-stop

This function is only to be used in an emergency e.g., if the Luna does not react or does not stop after releasing button on the hand control. The Emergency stop is placed on the hand control and on the side foil on the Luna. If the emergency stop has been activated all functions will stop immediately and the LED light will show red on the hand control. The Emergency stop can be deactivated by pressing the "Reset" button on the handset for 5 seconds.

Emergency lowering button

Emergency lowering is only to be used in an emergency where it is necessary to safely lower a patient. The emergency lowering button is placed on the hand control, illustrated as a parachute and on the side foil with 3 arrows pointing down.

To activate the emergency lowering, press and hold the button on the hand control or on the side foil for 5 seconds. The Luna will continue to beep while the button is held down. After 5 seconds the Luna will lower the patient. The button must be held down to continue lowering of the patient.

Note: On some models, emergency lowering works even if the hand control has a defect. Try using the button on the front panel instead. If neither works, use the manual emergency lowering feature described in the next section.



The Luna must be active before emergency lowering can be activated. Press the up or down button first.

The lower endstop is not active when emergency lowering is used. Release the emergency lowering button before the strap is at its full length.

Manual emergency lowering:

The manual emergency is used to lower the client when the powered emergency lowering does not work or if the hand control is defective.

Follow the instructions on the charger or follow the description below:

Fig. 1) Remove the hand control.

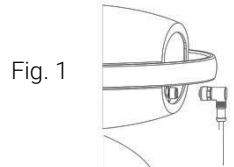

Fig. 2) Remove the plug on the side of the Luna.



Fig. 3) Take the key, which is placed at the top of the charger. Put the key into the Luna and turn the key counterclockwise to lower the user.



Note: Scan the QR-code and see the instructions on video.



If one of the emergencies stop functions has been activated due to an emergency, the Luna must not be used again before a check has been made and any defect repaired.

If in doubt, contact your dealer or Winnicare.

2.6 Charging

The Luna can be charged by placing the hand control in the charging station mounted on the wall or in the charger unit on the Luna Trolley. The charger unit is connected to the mains.

There are approximately ~80 lifts/100 kg (220 lbs) per. charging

Note: The Luna is fitted with batteries that require regular charging. WinnCare recommends that the Luna is charged every night or when the unit is not in use.

The Luna is fitted with a diode (marked BATT.) on the hand control and front panel which gives the following information concerning battery condition during use:

Diode colour	Description
Green	<ul style="list-style-type: none">• When charging starts the LED on the hand control and front panel will flash.<ul style="list-style-type: none">◦ After 2 minutes the flashing stops, but the Luna continues charging.• To check the charging status, simply remove and reinsert the hand control in the charger<ul style="list-style-type: none">◦ A constant light indicates that the Luna is fully charged. The light turns off after 2 minutes. <p>Note: On some models the light may not turn off</p>
Yellow	<ul style="list-style-type: none">• The LED on the Luna cassette lights and indicates that the batteries are approx. 50% discharged.• Recommend charging to avoid low battery.
Red	<ul style="list-style-type: none">• The LED on the Luna cassette lights and indicates that the batteries have reached a critical point.• The LED starts flashing and an acoustic ("beep" signal) will be heard.• Luna must IMMEDIATELY be put on charge in this situation and remain on charge for 5 hours.

Note: Luna cannot be overcharged.

3 USING LUNA

Luna is ready for use if all the assembly instructions have been followed correctly.

Note: The two carry handles placed on the Luna, is only used for installation- /transportation.

3.1 Using lifting slings

Luna spreader bars are designed for use with Winncare lifting slings.

Winncare lifting slings have 2-6 lifting straps and are designed for lifting hooks with a minimum diameter of 8 mm (0.31 In).

Use of non-approved slings will make Winncare's responsibility for faults and accidents null and void. Winncare can assist in choosing slings and the correct use of slings.

Attaching slings to the Winncare spreader bar

Winncare accepts no responsibility if slings are placed incorrectly. The caregiver/helper are responsible for ensuring that a sling is mounted correctly and fit for the situation.

- 1) Hygienically, the hook can be opened / closed without direct contact with the hook. Hold the spreader bar with one hand and place the loop strap around the hook and pull the strap towards yourself (Fig. 3.1A).
- 2) The sling strap is placed over the hook in its open position (Fig. 3.1B).
- 3) The sling strap is pulled downwards so that the hook locks (Fig. 3.1C).



Fig. 3.1A

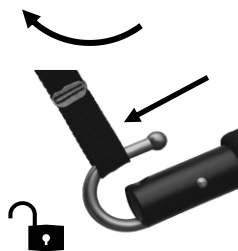

Fig. 3.1B



Fig. 3.1C

The design of the lifting hook is that the weight of the patient/user helps to close the hook.

To release the sling strap after lifting simply pull upwards to open the hook.



Note: Follow the instruction above to avoid pinching fingers.

3.2 Room to room transfer

It is possible to move a patient from room to room in 2 different ways. To ensure that the transfer is done correctly without any risk for the client, follow description:

A) Transfer with two Luna's or B) Transfer with one Luna.

A) Transfer with two Luna's

Note: only possible when using a special spreader bar.

- 1) In this lifting situation, the two Lunas (a and b) are placed as close together as possible.

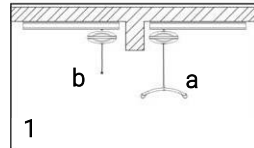

- 2) The lifting strap from Luna (b) is extended and attached to the extra suspension point on the spreader bar.

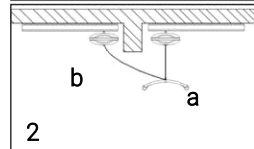

- 3) Now both Lunas are connected to the spreader bar. Check that the hook from the receiving Luna (b) is fitted correctly. Lower the strap on Luna (a) and raise the strap on Luna (b) as seen on picture 3.

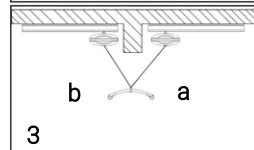

- 4) Lower the lifting strap on Luna (a) until the strap is hanging loose. Now all weight is on Luna (b)

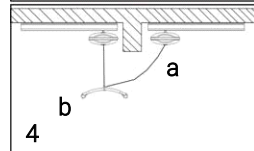

- 5) On the spreader bar, un-hook the strap from the Luna (a) by releasing the safety spring-plate on the strap hook.

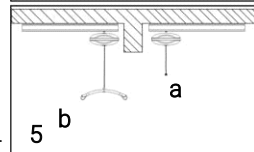

- 6) The transfer can now continue with the Luna (b).

B) Transfer with one Luna

Note: only possible when using a room-to-room Luna.

- 1) In this lifting situation Luna (a) is moved, as close as it is possible to the carts.
- 2) Luna (a) with user is moved to the door and the transfer strap (b) from the other room is fitted to the vacant ring bracket on Luna (a).
- 3) Now both straps (a and b) are fitted to the Luna cassette. Check the hook is fitted correctly.
- 4) The strap on Luna (a) is slowly released until the transfer strap (b) carries weight of the user.
- 5) The strap on Luna (a) can now be removed and fitted on the cart next to the transfer strap. The lifting strap is best removed by bringing the bracket up, press the spring and remove.

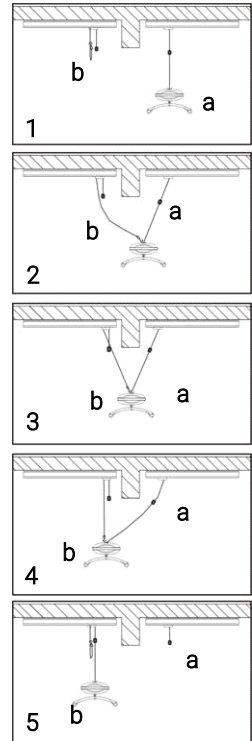

Note: It may be necessary to adjust the length of the strap (see below).

Adjusting the length of the strap

The length of the strap can be adjusted to fit the distance between the tracks in the two rooms.

- 1) The screw (a) is released.
- 2) The strap is placed in the correct position and the bolt (b) is placed in the corresponding loop (c).
- 3) Ensure that the screw (a) and the bolt (b) are tightened before the Luna is mounted on the cart.

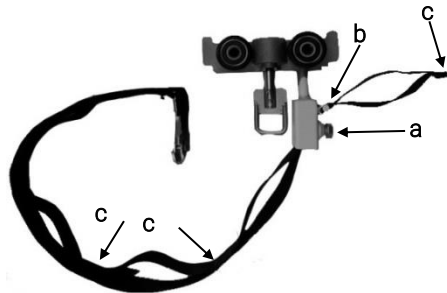

3.3 Using Luna in a shower or bathing environment

The Luna_{IPx4} and the hand control are water resistant and can tolerate being sprayed with water. WinnCare recommends that the Luna is used as shown in fig. 3.2A and 3.2C. It may be an advantage to use Luna mounted directly on the track as fig. 3.2C.



Fig. 3.2A – Right



Fig. 3.2B – Wrong

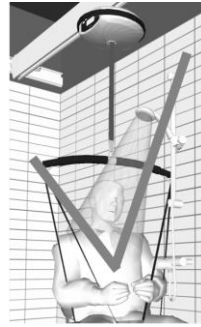

Fig. 3.2C – Right

Note: IPx4 hand control cannot withstand being immersed in water. As an accessory, it is possible to buy a waterproof IPx7 hand control, which withstands to be immersed in water.

4 MAINTENANCE

4.1 Cleaning

The Luna may be cleaned using a slightly damp cloth with a small quantity of standard household cleaning agents. Strong chemicals or abrasive agents must not be used.

4.2 Storage

The Luna must be stored in a dry environment with relative humidity under 70 %.

Note: The Luna should be fully charged before storing. The batteries will slowly discharge, so it is recommended that the Luna is recharged every 3 months to prevent the battery from being destroyed.

5 CHECK, WARRANTY AND TROUBLESHOOTING

5.1 Annual inspection

WinnCare recommends annual service in accordance to Standard EN/ISO 10535:2007. The product owner has the full responsibility to ensure that the annual service is performed. Annual service must be performed by WinnCare or qualified technical personnel. If replacing product parts, use only original spare parts from WinnCare.

Special requirements apply to the Luna and track systems installed in aggressive environments such as swimming pool and spa areas, horse riding halls or similar facilities. Here it is required to carry out an extended annual service performed by WinnCare, or other technically qualified personnel trained by WinnCare.

Product parts damaged from corrosion, tear or wear must be replaced ONLY with original spare parts from WinnCare.

For a continuous safe installation and in order to maintain a valid warranty, all load bearing parts must be replaced every 5 years ONLY with original parts from WinnCare.

Warranty

The Luna_{IPx4} has a 5-year warranty. See further warranty provisions on www.WinnCare.com

5.2 Troubleshooting

Fault	Possible cause	Solution
Luna does not react when the hand control UP/DOWN are used. (no "beep" sound from the Luna unit).	Luna is not on, or emergency stop is activated.	Turn on the Luna. Deactivate emergency stop (see section 2.5).
	Defective hand control.	Check if up/down buttons on the Luna unit. If it works, try another hand control or get a new one from the dealer or WinnCare
	Batteries are not fully charged or defective.	Charge batteries (see section 2.6) If this does not help, the batteries must be replaced.
Fault	Possible cause	Solution
Luna does not react when UP/DOWN buttons on the hand control are used. ("a" beep" sound is heard).	Spreader bar not mounted.	Mount the spreader bar (see section 2.2).
	Luna unit is not mounted correctly on the track/ cart.	Read the mounting instructions and follow section 2.1 for correct mounting of the Luna in track system.
	Batteries are not fully charged.	Charge batteries (see section 2.6).

	The strap is rolled incorrectly.	Request service technician from dealer.
Fault:	Possible cause	Solution
The lift does not react when the hand control UP-button is used. (a "beep" sound from the Luna unit).	The lifting capacity has been exceeded – User too heavy or sling has been caught on furniture etc.	Charge batteries if this does not help the batteries must be replaced.
Fault:	Possible cause	Solution
Does not charge.	Charger is not connected to the main supply.	Connect charger to main supply. (See section 2.6).
	Charger defect.	Try another charger or get a new one from the dealer or WinnCare.
	Connection to the hand control is defective.	Try another charger or get a new one from the dealer or WinnCare.

6 TECHNICAL DATA AND DIMENSIONS

6.1 Technical specifications

Max capacity: 200 kg or 275 kg (440 lbs or 606 lbs), depending on model
 Length of lifting strap: 2200 mm (86.6 In) Luna SKY 2400 mm (94.4 In)
 Lifting range: 2025 mm (79.7 In)
 Weight: 6.7 kg (14.7 lbs) without spreader bar. Luna SKY 7.4 kg (16.3 lbs)
 Measurements: 320 x 130 mm (12.6 x 5.1 In)
 Battery operation: 36 V lead acid batteries
 Charging: 100 - 240 V, 0.5 amp.
 Covering: High impact, moulded ABS
 Noise: LwA during lifting/lowering without load is 49dB(A)
 LwA during lifting/lowering with 175 kg (386 lbs) load is 53dB(A)

P-class: Lifting module: IP24
 Charger: IP40
 Hand control: IP64 / IP67 (Depending on model)
 Output: 24 V (Only available in the 2-channel model)

EMC tested according to following standards:
 Luna & Luna SKY IPx4 200 kg (441 lbs) 1 channel: IEC 60601-1-2:2015
 Other models: IEC 60601-1-2:2007.

6.2 Dimensions

Luna bayonet:

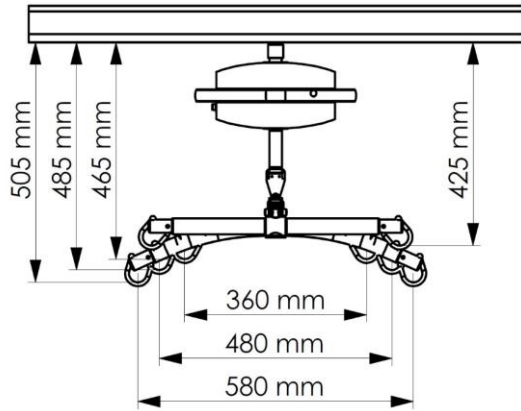

Luna strap:

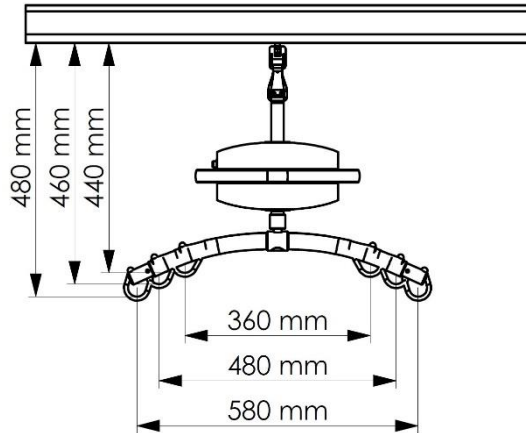

Luna SKY:

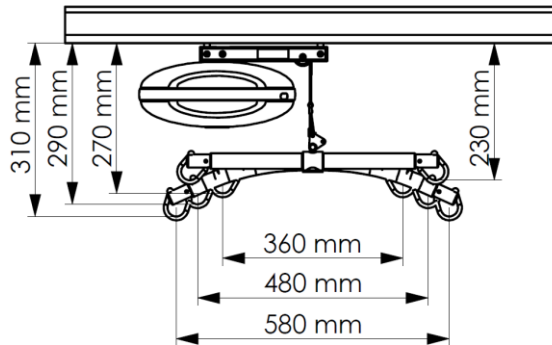

7 ENVIRONMENT AND QUALITY

7.1 Expected lifetime

The Luna has an expected lifespan of 20 years or 30.000 lifts if annual service has been done and complies to the instruction of section 5.1.

7.2 Disposal

Disposal of the equipment can be made through Winncare. After Luna's useful lifetime Winncare will receive the unit back and split the individual fractions in an environmentally friendly way either through reuse or recycling. Fractions that contain aluminium, lead acid batteries, ABS plastic, steel may damage the environment if not handled in an environmentally responsible way.

7.3 Battery

The Luna is equipped with batteries which may be returned either to the local recycling station or to Winncare at the end of their lifetime.

7.4 Quality

Winncare is certified according to the quality standard ISO 9001:2015 and ISO 13485:2016.

These certifications mean that the products and the company comply with the international standards for quality management and standards for traceability of medical products.

Luna_{IPx4}/200 and Luna_{IPx4}/275 is classified as a medical device class 1 product.

7.5 Symbols and abbreviations



Direct current



Double insulated



Type B, patient is not separated from the ground



The product should be recycled where possible



Refer to the user manual

SWL

Safe working load = (user + sling)

8 ACCESSORIES

Hand control

015-03101	Hand control, 1320 mm (52 In) cable, 1 channel
015-03102	Hand control, 1620 mm (63 In) cable, 1 channel
015-03103	Hand control, 1900 mm (75 In) cable, 1 channel
015-03105	Hand control, 1320 mm (52 In) cable, wire top, 1 channel
015-03106	Hand control, 1320 mm (52 In) cable, 2 channels
015-03107	Hand control, 1620 mm (63 In) cable, 2 channels
015-03108	Hand control, 1900 mm (75 In) cable, 2 channels
015-03109	Hand control, IPx7, 1320 mm (52 In) cable, 1 channel



Standard spreader bar, Luna

015-02108	Spreader bar - Strap, 36 cm (14 In)
015-02110	Spreader bar - Strap, 48 cm (19 In)
015-01968	Spreader bar - Strap 58 cm (23 In)
015-02129	Spreader bar - Bayonet, 36 cm (14 In)
015-02126	Spreader bar - Bayonet, 48 cm (19 In)
015-02128	Spreader bar - Bayonet, 58 cm (23 In)



Straight spreader bar with option for room to room

015-02117	2-point spreader bar with dobble hook 36 cm (14 In)
015-02118	2-point spreader bar with dobble hook 48 cm (19 In)
015-02119	2-point spreader bar with dobble hook 58 cm (23 In)



3-point spreader bar

015-02104	3-point spreader bar/Strap
015-02106	3-point spreader bar/Bayonet



4-point spreader bar

015-02100	4-point spreader bar/Strap
015-02102	4-point spreader/Bayonet



Accessories

015-02017	Trolley
015-02013	Extension arm, 1500mm (59 In)
015-02012	Extension arm, 1000mm (39 In)
015-02010	Extension arm, 600mm (24 In)

A complete list of spare parts is available. Please contact Winncare for details.

Warning! Do not use cables or accessories not included in the list as other cables or accessories may negatively affect performance or cause disturbance.

9 EMC data

Note: EMC data only valid for LunaIPX4 200 kg. (441 lbs) 1 channel sold from 1/1-2020 and onwards. Standards / Normative applied to EMC data: EN / IEC 60601-1-2-2015.

Guidance and manufactures declaration for electromagnetic emissions			
Emission standard	Type	Compliance to standard	
CISPR 11	RF-emissions	Yes, Group 1, Class B	
EN/IEC6100-3-2	Harmonic emission	Not applicable. Power < 75W	
EN/IEC6100-3-3	Voltage fluctuations/flicker	Yes	
Guidance for application Environment			
The LunaIPX4 is suitable for use in both professional as well as domestic environments including environments were connected to the public low-voltage network.			
Guidance and manufactures declaration for electromagnetic immunity			
Emission standard	Type	Compliance level	Specific guidance for application environment
EN/IEC61000-4-2	Electrostatic discharge (ESD)	± 8kV contact Up to ± 15kV air	Suitable for use on wood, concrete, or ceramic floor materials. Keep relative humidity below 30% when used on floors of syntenic materials e.g. carpets.
EN/IEC61000-4-4	Electrical fast transients and bursts	± 2kV power-supply ± 1kV for signal lines	The LunaIPX4 is battery powered during operation and hence the internal battery ensures operation during mains voltage disturbances. The LunaIPX4 is suitable for use with mains connected to a power supply with the quality of a public low-voltage network supplying domestic environment. Portable and mobile radio devices, including the wires, should not be used closer to the unit than the recommended safe
EN/IEC61000-4-5	Surge	± 1kV for signal lines	
EN/IEC6100-4-11	Dips, interruptions, and variations on power supply input	Angles: 0; 45; 90; 135; 180; 225; 270; 315 degrees Cycles: Dips 0.5x, Interruptions: 10x Mains freq.	
EN/IEC6100-4-8	Power frequency magnetic field	30 A/m 50/60 Hz	

EN/IEC 61000-4-6	Conducted disturbances, induced by RF fields	150kHz to 80MHz 3V RMS (6V ISM)		distance or 30 cm, or calculated using the equation for the transmission frequency. Recommended safe distance: $d = 1.17 \sqrt{P}$ for 80 MHz to 800 MHz $d = 2.33 \sqrt{P}$ for 800 MHz to 2.5 GHz with P as the maximum rated power of the transmitter in watts and d the recommended safe distance in meters.
EN/IEC6100-4-3	Proximity fields from RF wireless communication equipmEN/IECt	80 MHz to 2.7 GHz, 80% AM at 1 kHz		
		Test freq. MHz	V/m	Power frequency magnetic fields should be at levels typical to professional or domestic Environment.
		385	27	
		450	28	
		710	9	
		810	27	
		1,72	28	
		2,45	28	
		5,24	9	

Manufacturer:
WinnCare Nordic ApS
Taarnborgvej 12 C
4220 Korsoer
Denmark

Phone: + 45 70 27 37 20
Fax: + 45 70 27 37 19
Email: info@WinnCare.dk
www.WinnCare.com

(EU) 2017/745 CLASS I
EN/ISO 10535:2007
IEC 60601-1-2:2015

UM-910-00766EN

